

RFD22301, RFD22102
CE • ETSI • IC • FCC
Approved & Certified

DATASHEET

RFD22102 RFduino DIP

RFD22121 USB Shield
RFD22122 RGB LED / Button Shield
RFD22123 Servo Shield
RFD22124 PCB USB Shield
RFD22125 Proto Shield

RFD22126 Dual AAA Battery Shield
RFD22127 Single AAA Battery Shield
RFD22128 CR2032 Battery Shield
RFD22130 MicroSD Shield
RFD22131 Dual Relay Shield

RFD90101, RFD90102, RFD90103, RFD90104, RFD90105 Eval / Dev Kits

An RFduino "Shield" is a modular accessory that directly plugs into the RFduino.

**Shrunk an Arduino to the size of a finger-tip
and made it Wireless!**

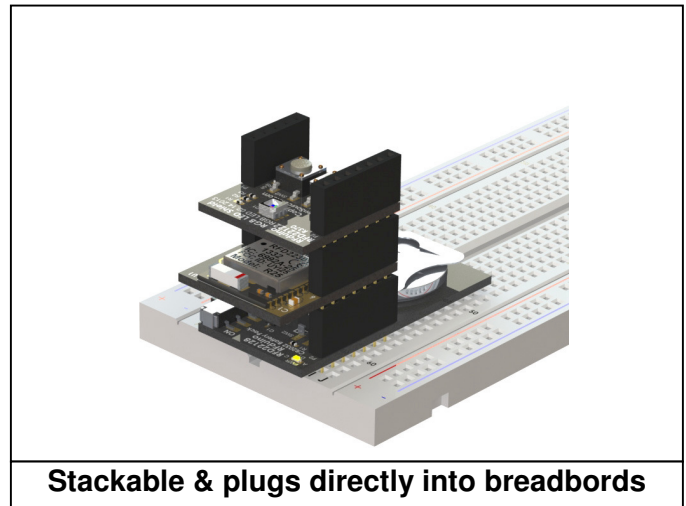
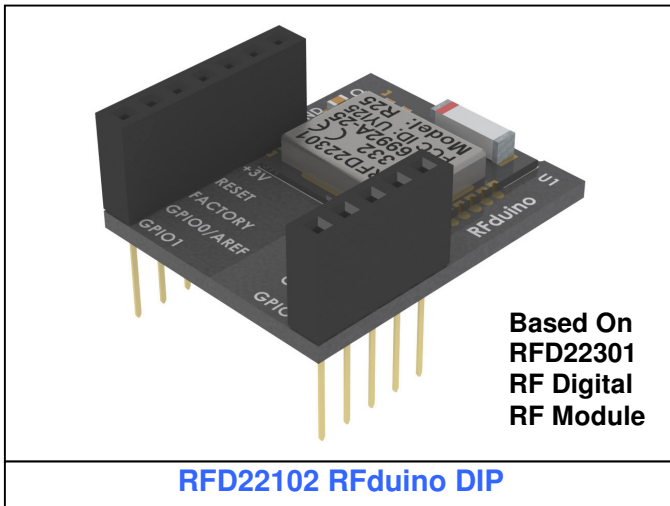

**RFduino is a Bluetooth 4.0 Low Energy BLE RF Module
with Built-In ARM Cortex M0 Microcontroller
for Rapid Development and Prototyping Projects**

**Simple to use Arduino IDE and sketches
running on professional grade hardware**

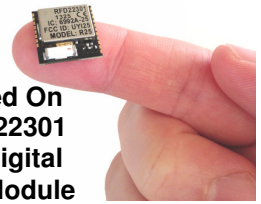

RFD22301, RFD22102
CE • ETSI • IC • FCC
Approved & Certified

RFD22102 RFduino DIP

The RFduino is a Bluetooth 4.0 Low Energy BLE RF Module with Built-In ARM Cortex M0 Microcontroller for Rapid Development and Prototyping Projects. It features the RFD22301 SMT Module.

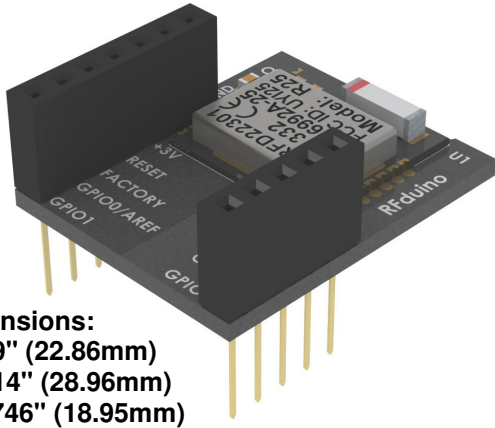

Dimensions:
X: 0.9" (22.86mm)
Y: 1.14" (28.96mm)
Z: 0.746" (18.95mm)

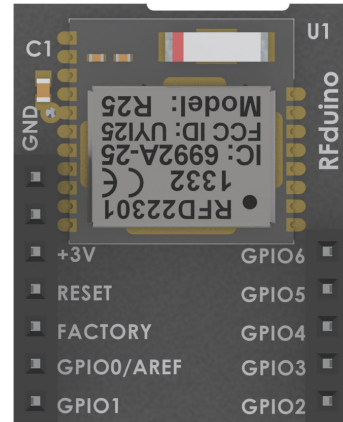

Description	Min	Nom	Max	Notes
VDD - Supply Voltage	2.1 V	3.0 V	3.6 V	
General Purpose I/O (GPIO) input high voltage	0.7 * VDD		VDD	
General Purpose I/O (GPIO) input low voltage	VSS		0.3 * VDD	
Output standard drive current		0.5 mA		
Output high drive current		5 mA		Max 3 pins
ULP Current with RC OSC Running		4uA		
Transmit Current		12mA		
Receive Current		12mA		
ARM CPU Running Current		4mA		

RFD22102 Programming Interface

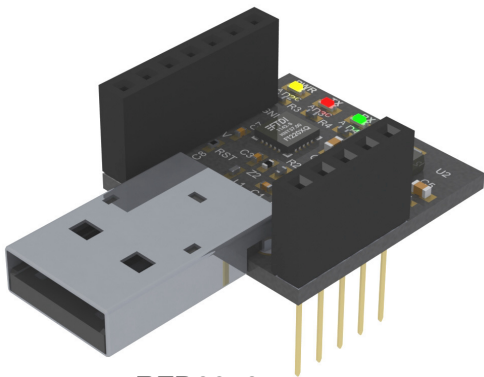

**RFD22121
USB Programmer
(Included in dev kits)**

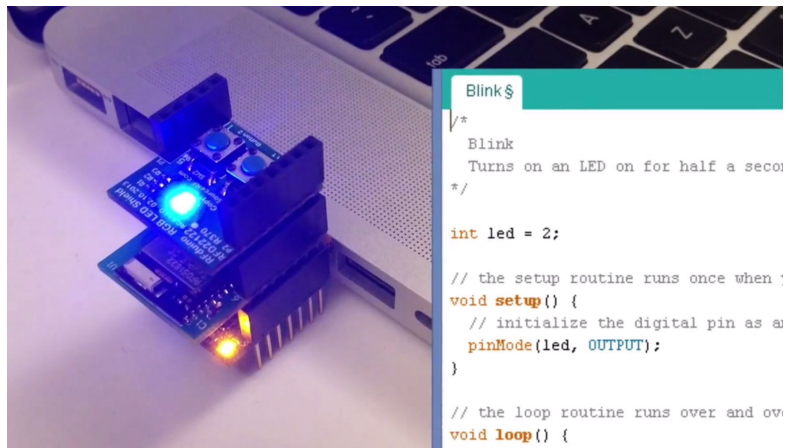

```

Blink$
/*
 * Blink
 * Turns on an LED on for half a second
 */

int led = 2;

// the setup routine runs once when :
void setup() {
  // initialize the digital pin as an
  pinMode(led, OUTPUT);
}

// the loop routine runs over and over
void loop() {
  ...
  }
  
```

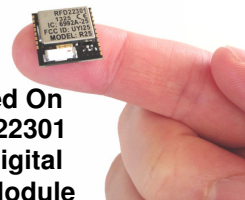

RFduino IDE & Programming Tools

Program the RFD22102 RFduino DIP using the Arduino IDE.
Download RFduino Quick Start Guide: <http://forum.rfduino.com/index.php?topic=14.0>
Or go to <http://RFduino.com/> and click on **Forum**.

Using the free Arduino IDE you can instantly load many different pre-written examples and be up and running with your applications quickly and easily.

Open Source iOS sample apps for iPhone and iPad are available in the Apple App Store
In the <http://www.RFduino.com> there is already an Android sample app published, it is the first of many others to follow which are contributed by the RFduino community.

Download RFduino library: <https://github.com/RFduino/RFduino>
Or go to <http://RFduino.com> and click on **Download**.

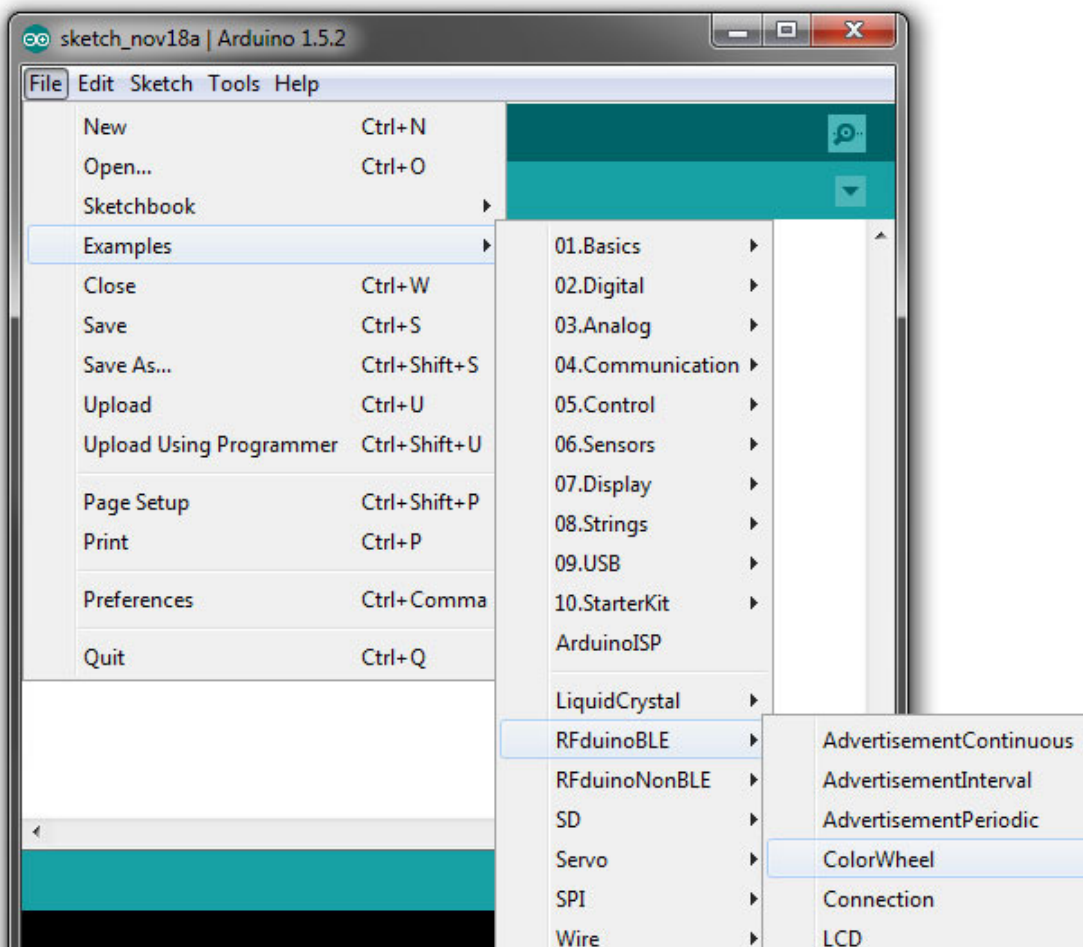

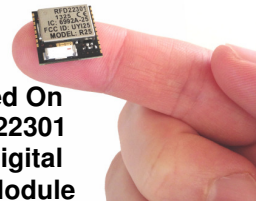

iOS Sample Apps for iPhone & iPad

There are currently 4 iOS sample Apps in the Apple App Store for free download. There are also **Android apps** being developed by other developers, one of which has already been published on the RFduino forum located at <http://forum.RFduino.com>

The source for the sample Apps can be found at <https://github.com/RFduino>

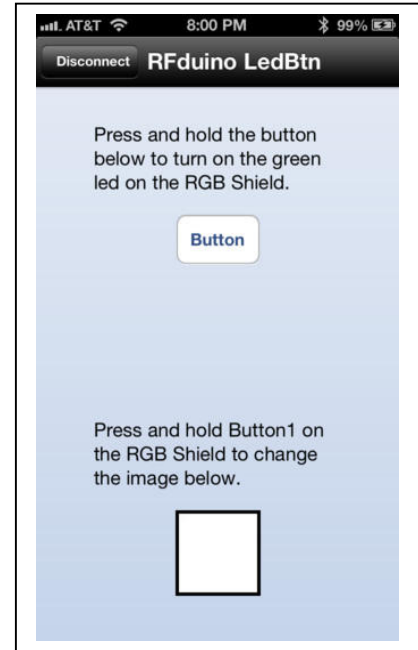
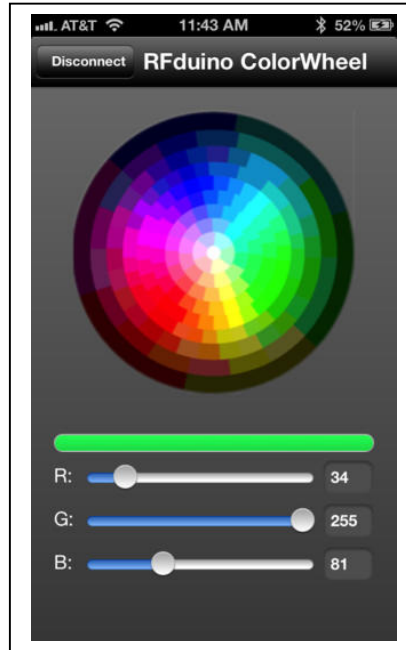
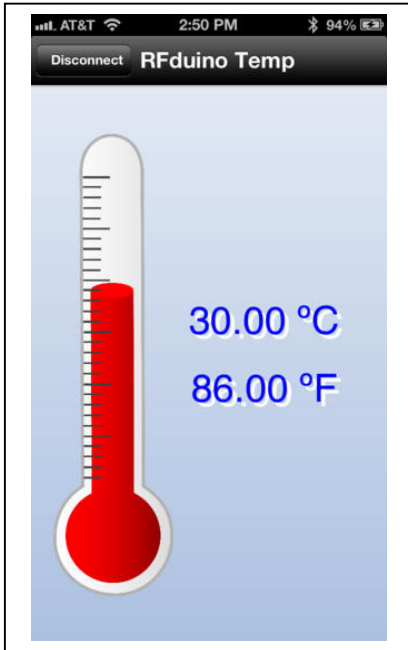

The links below direct to the App Store, where you can download the 4 sample apps to your iOS device (i.e. iPad / iPhone).

Temperature App:

<https://itunes.apple.com/us/app/rfduino-temperature/id668832196?mt=8>

Color Wheel App:

<https://itunes.apple.com/us/app/rfduino-colorwheel/id685753295?mt=8>

LED / Button App:

<https://itunes.apple.com/us/app/rfduino-ledbutton/id704045041?mt=8>

Servo App:

<https://itunes.apple.com/us/app/rfduino-servo/id692552931?mt=8>

Source for apps located at: <http://GitHub.com/RFduino>

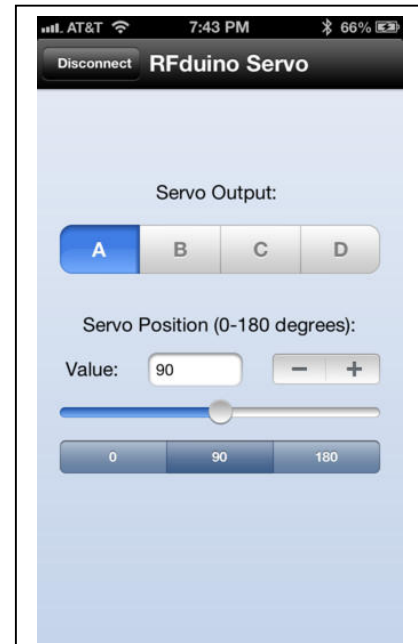

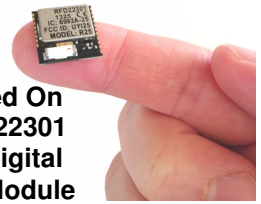

RFD22301, RFD22102
CE • ETSI • IC • FCC
Approved & Certified

RFD22121 USB Programming Shield

The RFD22121 USB Programming shield, plugs into any USB port and is used to load sketches (code) onto the RFduino. The RFD22121 can plug into any solderless breadboard and the RFduino can plug on top of it, or even below it. It can also be used as a UART with its on-board FTDI chip. Three color LEDs indicate TXD, RXD and Power. The on-board 3.3V regulator can be used to supply power to the RFduino as well as other shields and in some cases the rest of your circuit. Once code is loaded onto the RFduino, this RFD22121 programming shield can be detached to save size and cost. It can be used to program the RFD22102 RFduino DIP or the RFD22301 RFduino SMT module.

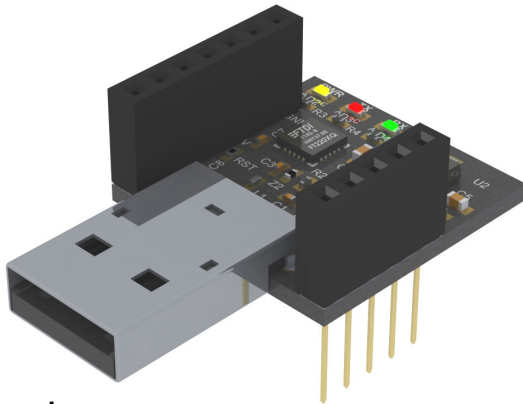

Dimensions:
X: 0.9" (22.86mm)
Y: 1.14" (28.96mm)
Z: 0.746" (18.95mm)

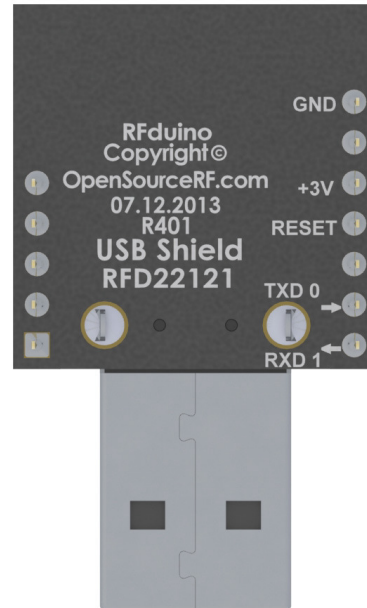

RFD22122 RGB LED / Pushbutton Shield

The RFD22122 RGB LED / Pushbutton shield plugs onto the RFduino. It has 2 button inputs with 10k resistor pull downs and it also has an RGB LED with series LEDs.

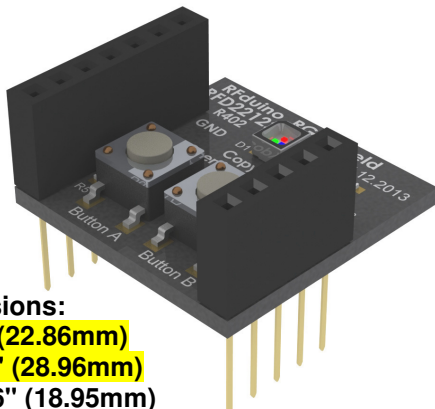

Dimensions:
X: 0.9" (22.86mm)
Y: 1.14" (28.96mm)
Z: 0.746" (18.95mm)

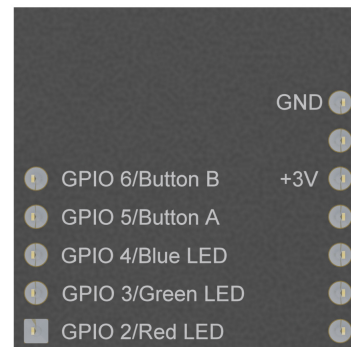

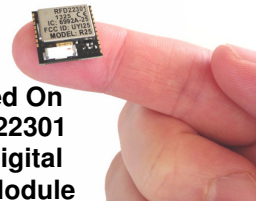

RFD22123 Servo Shield

The RFD22123 Servo shield plugs onto the RFduino. It can drive up to 4 servos and has a dual supply input. 3V input for RFduino interface and 5V to 6V supply input for driving the servos.

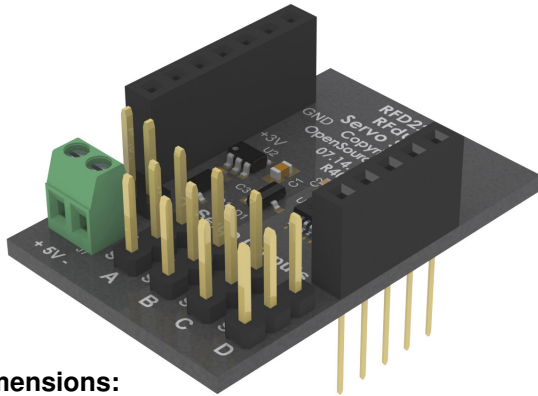

Dimensions:

X: 0.9" (22.86mm)

Y: 1.14" (28.96mm)

Z: 0.746" (18.95mm)

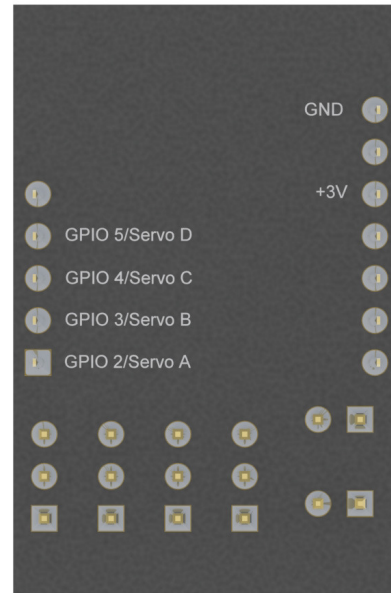

RFD22124 PCB USB Shield

The RFD22124 PCB USB shield is the exact same item as the RFD22121 USB shield shown above, except it does not have a formed metal USB connector, it instead uses a PCB type USB connector.

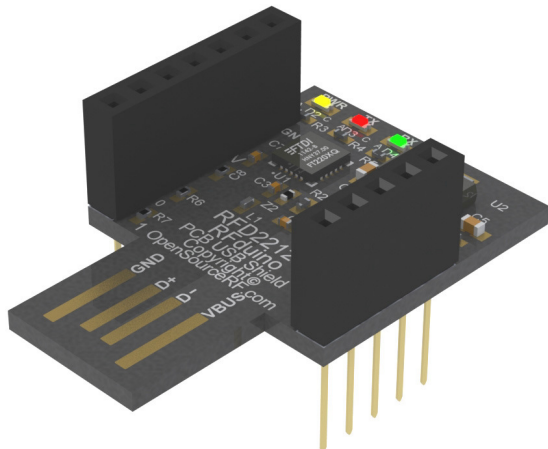

Dimensions:

X: 0.9" (22.86mm)

Y: 1.14" (28.96mm)

Z: 0.746" (18.95mm)

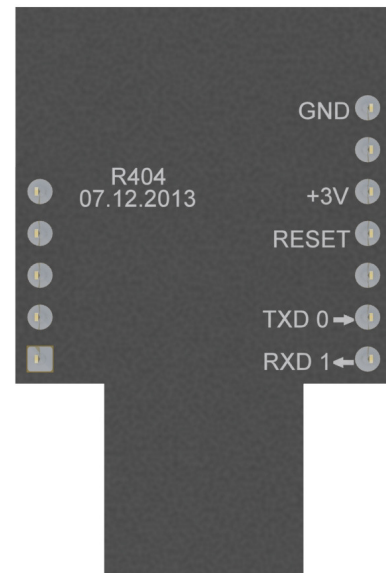

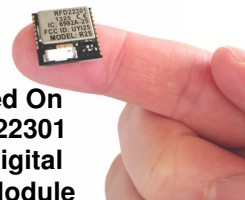

RFD22301, RFD22102
CE • ETSI • IC • FCC
Approved & Certified

RFD22125 Proto Shield

The RFD22125 Proto shield is used for building your own prototype shields for the RFduino. It provides access to the 3V supply rail and ground, in addition to a free grid area in the center for soldering.

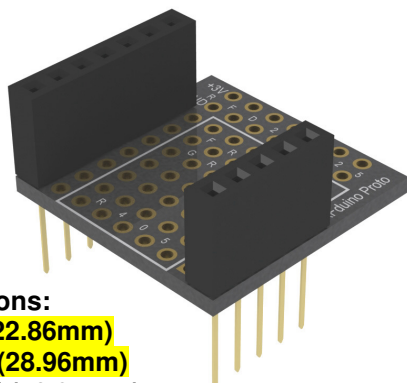

Dimensions:
X: 0.9" (22.86mm)
Y: 1.14" (28.96mm)
Z: 0.746" (18.95mm)

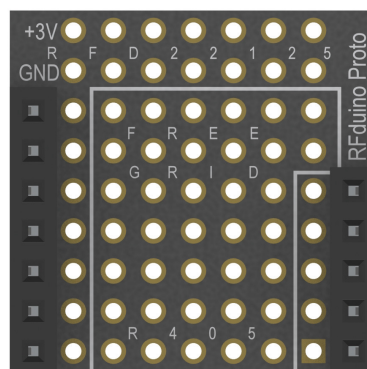

RFD22126 Dual AAA Battery Shield

The RFD22126 Dual AAA Battery shield, requires two AAA batteries. It has a step-up regulator that is set to supply 3.3V output, even when the AAA batteries drop in voltage as they run down over time.

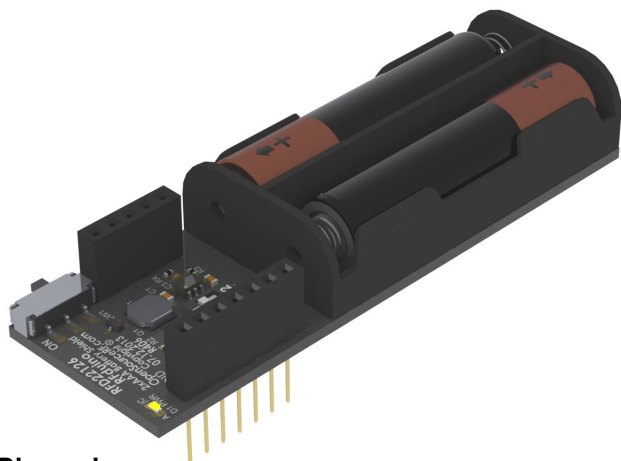

Dimensions:
X: 0.9" (22.86mm)
Y: 1.14" (28.96mm)
Z: 0.746" (18.95mm)

SW2		Pos	Description
1	<input type="checkbox"/> OFF		Step - UP Regulator OFF
	<input type="checkbox"/> ON		Step - UP Regulator ON
2	<input type="checkbox"/> OFF		Power - LED OFF
	<input type="checkbox"/> ON		Power - LED ON

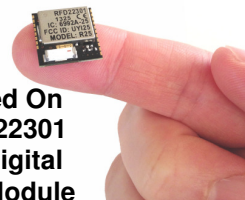

RFD22301, RFD22102
CE • ETSI • IC • FCC
Approved & Certified

RFD22127 Dual AAA Battery Shield

The RFD22127 Single AAA Battery shield, requires one 1.5V AAA battery. It has a step-up regulator that supplies 3.3V output, even when the 1.5V AAA battery drops in voltage as they run down over time.

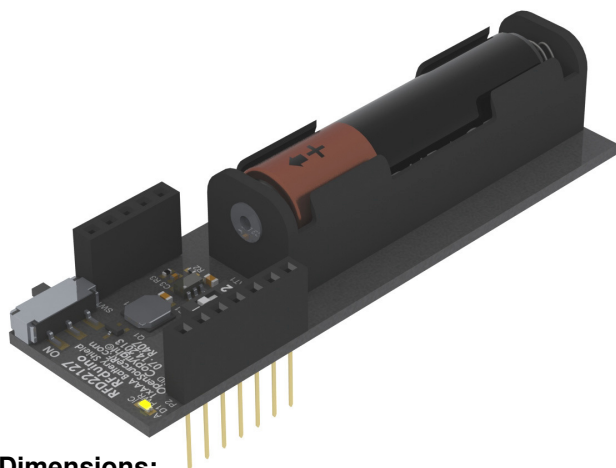

Dimensions:

X: 0.9" (22.86mm)
Y: 1.14" (28.96mm)
Z: 0.746" (18.95mm)

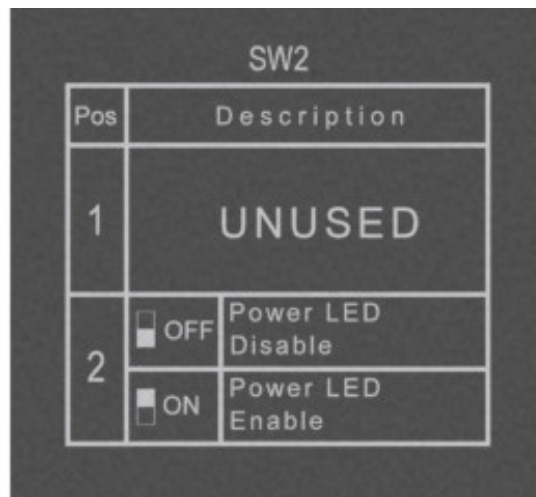

RFD22128 CR2032 Coin Battery Shield

The RFD22128 CR2032 Coin Battery shield, requires one CR2032 3V battery.

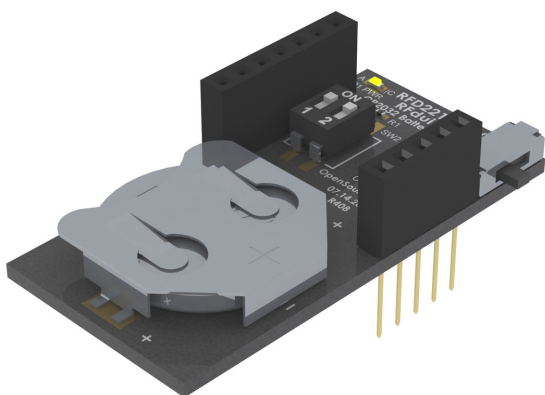

Dimensions:

X: 0.9" (22.86mm)
Y: 1.14" (28.96mm)
Z: 0.746" (18.95mm)

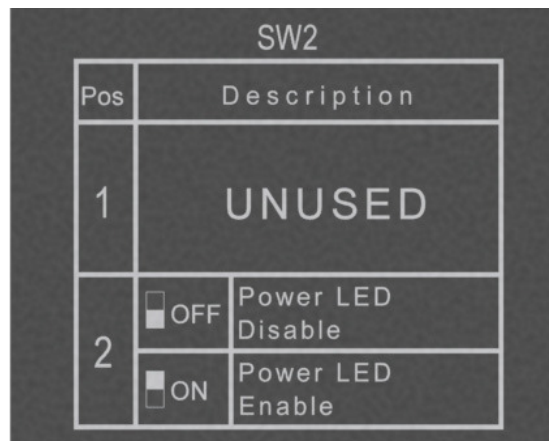

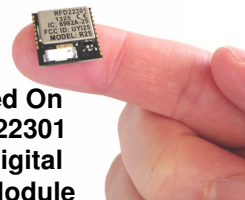

RFD22301, RFD22102
CE • ETSI • IC • FCC
Approved & Certified

RFD22130 MicroSD Shield

The RFD22130 MicroSD shield allows easy use of MicroSD for access to gigabytes of external memory.

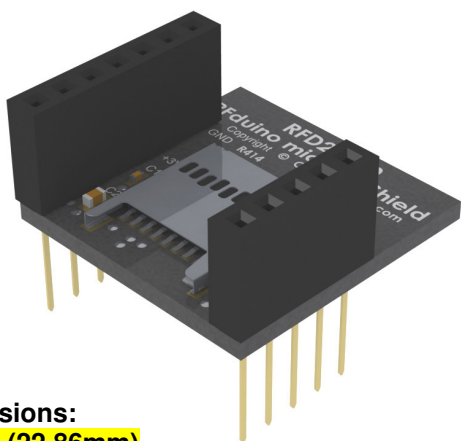

Dimensions:
X: 0.9" (22.86mm)
Y: 1.14" (28.96mm)
Z: 0.746" (18.95mm)

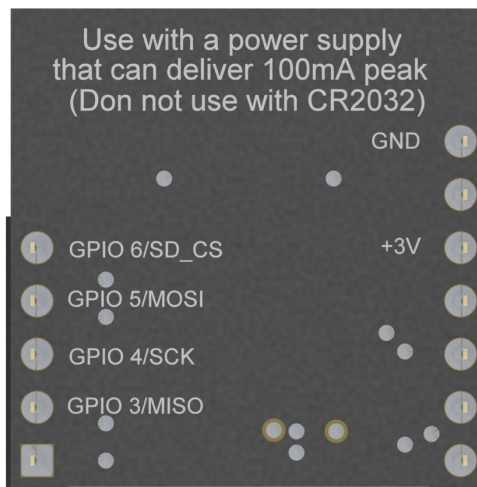

RFD22131 Dual Relay Shield

The RFD22131 Dual Relay shield provides two SPDT, independently controlled relays.

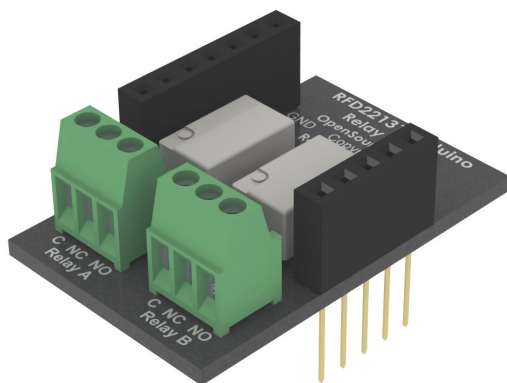

Dimensions:
X: 0.9" (22.86mm)
Y: 1.14" (28.96mm)
Z: 0.746" (18.95mm)



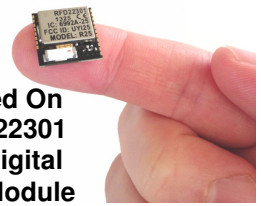

Rapid Development & Prototyping Kits

RFD90101 RFduino Dev Kit

RFduino
Rapid Development & Prototyping

Based on RFD22301 RF Module

KIT PART NUMBER
RFD90101
www.RFduino.com

Shrunk down an Arduino to the size of a finger-tip and made it Wireless

Plugs Into Breadboards
High Performance
Bluetooth 4.0 LE
Ultra Low Power
No Soldering
Runs on 3V

RoHS
IC & FCC Approved & Certified
CE (ETSI) Compliant

Easy To Use
Arduino IDE & Sketches
Running On Professional Grade Hardware

Kit Includes:
(1 ea) RFD22102 RFduino DIP
(1 ea) RFD22121 USB Shield

7 00371 95532 8
www.RFDUINO.com

RFD90102 RFduino Dev Kit

RFduino
Rapid Development & Prototyping

Based on RFD22301 RF Module

KIT PART NUMBER
RFD90102
www.RFduino.com

Shrunk down an Arduino to the size of a finger-tip and made it Wireless

Bluetooth 4.0 Low Energy
Easy To Use
Arduino IDE & Sketches
Running On Professional Grade Hardware

RoHS
Batteries Not Included
Runs On 3V

Kit Includes:
(2 ea) RFD22102 RFduino DIP
(1 ea) RFD22121 USB Shield
(1 ea) RFD22122 RGB LED / Button Shield
(1 ea) RFD22123 Servo Shield
(1 ea) RFD22125 Prototyping Shield
(1 ea) RFD22126 Dual AAA Battery Shield

CE (ETSI) Compliant
IC & FCC Approved & Certified

7 00371 95533 5
www.RFDUINO.com

RFD90103 RFduino Dev Kit

RFduino
Rapid Development & Prototyping

Based on RFD22301 RF Module

KIT PART NUMBER
RFD90103
www.RFduino.com

Shrunk down an Arduino to the size of a finger-tip and made it Wireless

IC & FCC Approved & Certified
CE (ETSI) Compliant

Kit Includes:
(2 ea) RFD22102 RFduino DIP
(1 ea) RFD22121 USB Shield
(1 ea) RFD22122 RGB LED / Button Shield
(1 ea) RFD22123 Servo Shield
(1 ea) RFD22124 PCB USB Shield
(1 ea) RFD22125 Prototyping Shield
(1 ea) RFD22126 Dual AAA Battery Shield
(1 ea) RFD22127 Single AAA Battery Shield
(1 ea) RFD22128 CR2032 Battery Shield
(1 ea) RFD22130 Micro SD Shield
(1 ea) RFD22131 Dual Relay Shield

Easy To Use
Arduino IDE & Sketches
Running On Professional Grade Hardware

Batteries Not Included
Runs on 3V
No Soldering
Ultra Low Power
Bluetooth 4.0 LE
High Performance
Plugs Into Breadboards

RoHS

7 00371 95534 2
www.RFDUINO.com

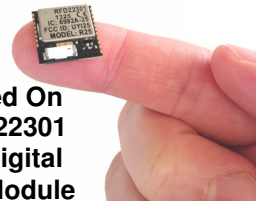

RFD90104 RFduino Dev Kit

RFduino
Rapid Development & Prototyping

Based on RFD22301 RF Module

KIT PART NUMBER RFD90104
www.RFduino.com

IC & FCC Approved & Certified

Shrunk down an Arduino to the size of a finger-tip and made it Wireless

CE (ETSI) Compliant

Batteries Not Included

RoHS

Runs On 3V
No Soldering
Ultra Low Power
Bluetooth 4.0 LE
High Performance
Plugs Into Breadboards

Kit Includes:
(5 ea) RFD22102 RFduino DIP
(2 ea) RFD22121 USB Shield
(1 ea) RFD22122 RGB LED / Button Shield
(1 ea) RFD22123 Servo Shield
(1 ea) RFD22124 PCB USB Shield
(1 ea) RFD22125 Prototyping Shield
(1 ea) RFD22126 Dual AAA Battery Shield
(1 ea) RFD22127 Single AAA Battery Shield
(1 ea) RFD22128 CR2032 Battery Shield
(1 ea) RFD22130 Micro SD Shield
(1 ea) RFD22131 Dual Relay Shield

Easy To Use Arduino IDE & Sketches
Running On Professional Grade Hardware

www.RFduino.com

RFD90105 RFduino Dev Kit

RFduino
Rapid Development & Prototyping

Based on RFD22301 RF Module

KIT PART NUMBER RFD90105
www.RFduino.com

Shrunk down an Arduino to the size of a finger-tip and made it Wireless

CE (ETSI) Compliant
IC & FCC Approved & Certified

RoHS

Runs On 3V
No Soldering
Ultra Low Power
Bluetooth 4.0 LE
High Performance
Plugs Into Breadboards

Kit Includes:
(10 ea) RFD22102 RFduino DIP
(2 ea) RFD22121 USB Shield
(2 ea) RFD22122 RGB LED / Button Shield
(2 ea) RFD22123 Servo Shield
(2 ea) RFD22124 PCB USB Shield
(2 ea) RFD22125 Prototyping Shield
(2 ea) RFD22126 Dual AAA Battery Shield
(2 ea) RFD22127 Single AAA Battery Shield
(2 ea) RFD22128 CR2032 Battery Shield
(2 ea) RFD22130 Micro SD Shield
(2 ea) RFD22131 Dual Relay Shield

Easy To Use Arduino IDE & Sketches
Running On Professional Grade Hardware

www.RFduino.com

CE, ETSI, IC, FCC Compliance Information

IC & FCC Compliance Information

The RFD22301 is IC and FCC Modular Approved and Certified for Canada and USA, therefore for use of the RFD22301 module in your product does not require further IC or FCC testing for an intentional radiator for compliance of the RFD22301. Detail instructions and IC and FCC notices shown later in this data sheet. Any modifications made to the RFD22301 will void the IC and FCC Approval and Certification. The RFD22301 has an integrated on-board chip antenna. You simply include the RFD22301 in your product and follow the IC and FCC notices and information below and place the appropriate label on your product to indicate that it includes an IC and FCC approved module and no further testing would be required for the module.

CE / ETSI Compliance Information

The RFD22301 is CE (ETSI) Tested. See declaration of conformity later in this document.

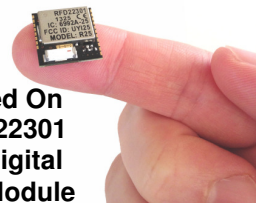

RFD22301, RFD22102
CE • ETSI • IC • FCC
Approved & Certified

RFD22102 RFduino DIP is based on RFD22301 SMT

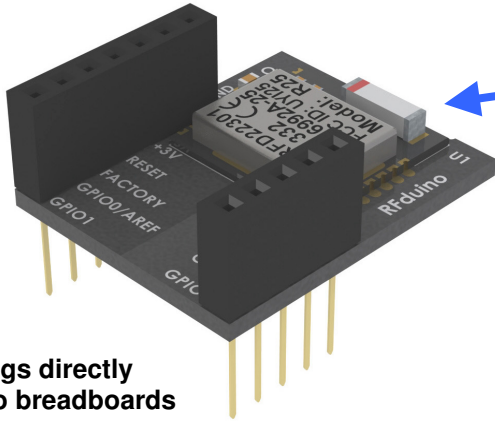

Plugs directly into breadboards



The RFD22301 compliance approved SMT module is placed onto a DIP board to create the RFD22102 RFduino DIP form factor.

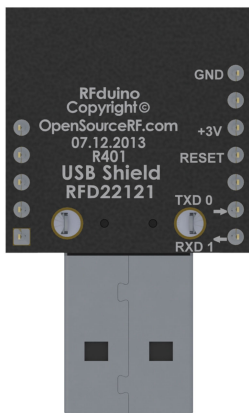
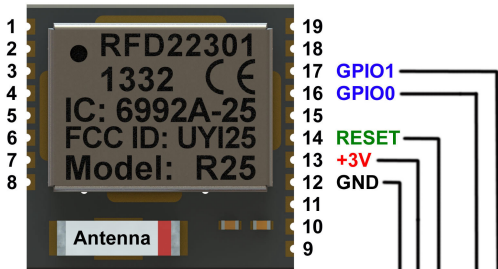

Here is the wiring diagram for the RFD22301 RFduino SMT Module for connecting to the RFD22121 USB programming (shield) dongle.

The RFD22102 RFduino DIP directly plugs into the RFD22121 USB programming module.

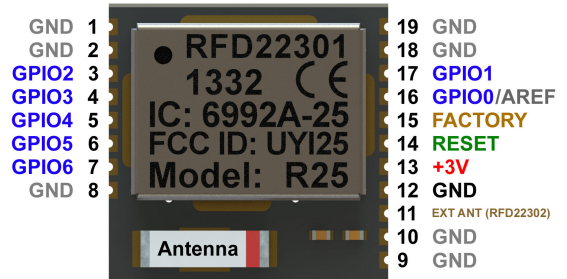

**CE, ETSI, IC, FCC
Approved & Certified**

See RFD22301 datasheet at:
<http://www.RFDigital.com/RFD22301>

RFD22301 RFduino SMT version is ideal for ultra small size applications and its perfect for integration into a product of your own.

The RFD22301 RFduino SMT is the core of the RFD22102 RFduino DIP and can be programmed using a simple 3 wire ISP interface while in your application.

Use RFduino shields and accessories for development and prototyping and then quickly and easily switch to the RFD22301 SMT module for production. The RFD22301 is available from RF Digital and suitable for RoHS high volume SMT (SMD) pick and place assembly.

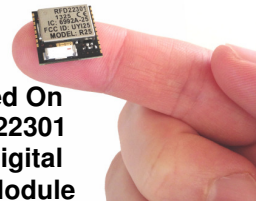

Industry Canada Information

This device complies with Industry Canada licence-exempt RSS standard(s). Operation is subject to the following two conditions: (1) this device may not cause interference, and (2) this device must accept any interference, including interference that may cause undesired operation of the device.

Le présent appareil est conforme aux CNR d'Industrie Canada applicables aux appareils radio exempts de licence. L'exploitation est autorisée aux deux conditions suivantes : (1) l'appareil ne doit pas produire de brouillage, et (2) l'utilisateur de l'appareil doit accepter tout brouillage radioélectrique subi, même si le brouillage est susceptible d'en compromettre le fonctionnement.

IC LABEL

Relating to Model Number R25 (RFD Part Number: RFD22301)

The unit should have a permanently attached label in a conspicuous location with the following statement:

Contains IC: 6992A-25

NOTES:

1. Industry Canada does not specify the size of the label or the lettering thereon. The only requirement is that the text be legible.

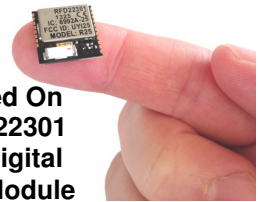

SAMPLE FCC STATEMENT TO BE INCLUDED IN USER'S MANUAL

Relating to Model Number R25 (RFD Part Number: RFD22301)

INSTRUCTION TO THE USER (if device DOES NOT contain a digital device)

The user is cautioned that changes or modifications not expressly approved by the party responsible for compliance could void the user's authority to operate this equipment.

INSTRUCTION TO THE USER (if device contains a digital device)

This equipment has been tested and found to comply with the limits for a class B digital device, pursuant to part 15 of the FCC Rules. These limits are designed to provide reasonable protection against harmful interference in a residential installation. This equipment generates, uses and can radiate radio frequency energy and if not installed and used in accordance with the instructions, may cause harmful interference to radio communications. However, there is no guarantee that interference will not occur in a particular installation. If this equipment does cause harmful interference to radio or television reception, which can be determined by turning the equipment off and on, the user is encouraged to try to correct the interference by one or more of the following measures:

- * Reorient or relocate the receiving antenna.
- * Increase the separation between the equipment and receiver.
- * Connect the equipment into an outlet on a circuit different from that to which the receiver is connected.
- * Consult the dealer or an experienced radio/TV technician for help.

In order to maintain compliance with FCC regulations, shielded cables must be used with this equipment. Operation with non-approved equipment or unshielded cables is likely to result in interference to radio and TV reception. The user is cautioned that changes and modifications made to the equipment without the approval of manufacturer could void the user's authority to operate this equipment.

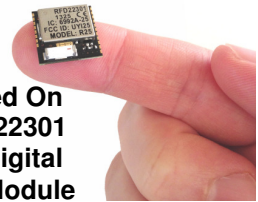

FCC LABEL

Relating to Model Number R25 (RFD Part Number: RFD22301)

The unit should have a permanently attached label in a conspicuous location with the following statement:

Contains FCC ID: UYI25

**This device complies with Part 15 of the FCC Rules.
Operation is subject to the following two conditions:**

- (1) This device may not cause harmful interference and**
- (2) this device must accept any interference received,
including interference that may cause undesired
operation.**

NOTES:

1. The FCC does not specify the size of the label or the lettering thereon. The only requirement is that the text be legible.
2. If the entire label can not be placed on the unit due to space constraint, only FCC ID may be displayed on the unit. In such cases, the compliance statement will have to be included in the "user's manual". NOTE: Device must be smaller than a man's palm.

** If the unit also interfaces with phone line, it requires additional information on the label - refer to part 68 information **

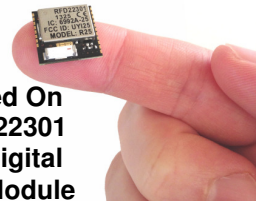

RoHS Declaration Of Conformity November 17, 2013

RF Digital declares that part numbers

- RFD22301
- RFD22102
- RFD22121
- RFD22122
- RFD22123
- RFD22124
- RFD22125
- RFD22126
- RFD22127
- RFD22128
- RFD22130
- RFD22131

are manufactured with RoHS materials.

RF Digital Corporation
1601 Pacific Coast Highway, Suite 290
Hermosa Beach, CA 90254

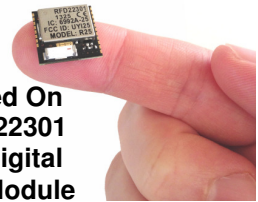

DECLARATION OF CONFORMITY

November 17, 2013

RF Digital declares that part numbers

- RFD22301 (Model Number R25)
- RFD22102

comply with ETSI EN 300 440-2 power requirements

as called out in the R&TTE V1.2.1 Directive

Technical documents for the above mentioned part numbers are held at

RF Digital Corporation
1601 Pacific Coast Highway, Suite 290
Hermosa Beach, CA 90254

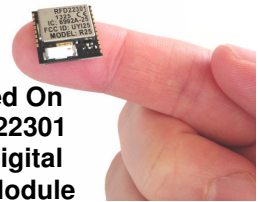

Important Notice

RFduino is being manufactured by RF Digital Corp. (hereafter referred to as RF Digital).

RF Digital reserves the right to make corrections, modifications, and/or improvements to the product and/or its specifications at any time without notice.

RF Digital assumes no liability for the user's product and/or applications.

RF Digital products are not authorized for use in safety-critical applications, including but not limited to life-support applications.

RF Digital assumes no liability for parts or their application beyond replacement or refunding the original purchase price.

All trademarks and trade names belong to their respective owners.

Information provided in this document is for reference only. The user must conduct testing and prototyping on their own for their own application. This document only provides an example of a possible use for the parts shown in this design and requires actual testing to confirm its accuracy or validity or proper application. There is NO suggestion that the devices shown in this document should be used for the implied application. There is no guarantee or warranty of suitability for any specific application. The information disclosed in this document is AS-IS. By using any information contained in this document you are assuming all risks and liability associated therewith. RF Digital reserves the right to make corrections, modifications, changes and/or improvements to specifications or details at any time without notice or obligation. RF Digital assumes no liability for the user's product and/or applications. RF Digital products are not authorized for use in safety-critical applications, including but not limited to life-support applications. RF Digital assumes no liability for parts or their application beyond replacement or refunding the original purchase price paid to RF Digital.

Limited Product Warranty

RF Digital warrants that RF Devices manufactured by RF Digital are free from defects in material and workmanship, for Ninety (90) Days from date of delivery. RF Devices covered by this warranty and returned to RF Digital within the Ninety Day Warranty Period will be eligible for replacement, repair, or credit, limited to the amount RF Digital was paid for the RF Device. To obtain a remedy under this Warranty, the following conditions must be met: (1) Customer must notify RF Digital in writing promptly on discovery of the deficiency with reasonable detail within the Warranty Period; (2) Customer must return the RF Devices to RF Digital promptly upon receipt of an RMA from RF Digital, at Customer's risk and expense; and (3) RF Digital confirms the claimed deficiency is present. If all of these conditions are met, RF Digital, at its sole option, will either replace or repair the RF Device or credit Customer's account for the amount the Customer paid to RF Digital for the RF Device.

End of document.